

FIBERSTONE

PLANTENBAKKEN, BLOEMBAKKEN, POTTEN



Fiberstone bakken zijn gemaakt van resinmix. Dat is kunststof met gemalen natuursteen. Een perfecte mix van de voordelen van kunststof, lichtgewicht, vorstbestendig, en de stijlvolle uitstraling van natuursteen.

E3003-S1-W-S3-01

Deze plantenbakken zijn online te koop bij www.plantenbakkenplanten.nl



-  frost resistant
-  weatherproof
-  UV proof
-  indoor



Index

Jumbo Glossy White	6
Jumbo XXL Fiberstone	10
Glossy Fiberstone	18
Balcony	30
Glossy Fiberstone Candlesticks	32
Fiberstone Picnic	34
Fiberstone	40
Small Pottery	56
Super Light Weight	64
Budget Eco Pottery	70
Light Clay	76
Light Stone Ceramic	84
Various	90
Q-line	92
Presentation	94





Bloemimex BV
www.plantenbakkenplanten.nl



E1076-S1-W, E1077-S1-W, E1078-S1-W en E1079-S1-W

Jumbo Glossy White



NL Een sterk, onderhoudsvriendelijk materiaal, met hoogglans autolak. De sterke lak is UV-bestendig en krasvast.

Materiaal en lak zijn vorstbestendig. Ook tijdens hogere (buiten)temperaturen blijven de artikelen vormvast. Kortom, geschikt voor zowel gebruik binnen als (permanent) buiten. Niet geschikt als waterbassin.

EN A strong maintenance free material and ultra glossy car lacquer. The strong lacquer withstands UV-light and is scratch resistant.

Material and lacquer are frost resistant. High(er) outside temperatures have no influence on the steadiness of the shapes. In short, fit for both inside and (permanent) outdoor use. Not suitable as a water basin.

DE Ein kräftiges Material mit hochglänzendem Autolack. Dieser starke Lack braucht keinen besondere Pflege, ist UV-resistent und kratzfest.

Das Material und die Lackschichten frieren nicht kaputt. Bei höheren Außentemperaturen bleibt das Material formfest. Im Kurzem: empfohlen für drinnen und draußen. Nicht zu benutzen als Wasserbassin.

Jumbo

Set of 1

Without feet

- E1076-S1-W XL
- E1077-S1-W L
- E1078-S1-W M
- E1079-S1-W S



E1076 H 92 | L 110 | W 110

E1077 H 82 | L 90 | W 90

E1078 H 62 | L 70 | W 70

E1079 H 48 | L 50 | W 50

Jumbo Middle High

Set of 1

- E1069-S1-W XXL
- E1070-S1-W XL
- E1071-S1-W L
- E1072-S1-W



E1069 H 90 | L 140 | W 140

E1070 H 70 | L 110 | W 110

E1071 H 60 | L 90 | W 90

E1072 H 63 | L 70 | W 70





E1122-S1-W

Jumbo seating

Set of 1

E1122-S1-W



H 47,5 | L 140 | W 140



Jumbo seating

Set of 1

E1129-S1-W XXXL

E1123-S1-W XXL



E1129 H 45 | L 200 | W 80

E1123 H 45 | L 150 | W 80



Jumbo XXL Fiberstone



NL

- royale afmetingen voor beplanting
- zeer geschikt voor openbare ruimtes
- hufferproof
- los verkrijgbaar
- zeer sterk
- 100% natuurlijk, maar toch licht in gewicht

EN

- royal sizes for planting
- well suited for public spaces
- vandalism resistant
- single pieces

DE

- geräumig für pflanzen
- sehr geeignet für öffentliche Plätze
- Vandalismus resistent
- einzeln zu kaufen

Alle hoeken extra verstevigd
All corners extra reinforced
Alle Ecken extra verstärkt



Jumbo

Set of 1

Without feet



■ E1076-S1-01 XL	H 92 L 110 W 110
■ E1076-S1-03 XL	H 92 L 110 W 110
■ E1077-S1-01 L	H 82 L 90 W 90
■ E1077-S1-03 L	H 82 L 90 W 90
■ E1078-S1-01 M	H 62 L 70 W 70
■ E1078-S1-03 M	H 62 L 70 W 70
■ E1079-S1-01 S	H 48 L 50 W 50
■ E1079-S1-03 S	H 48 L 50 W 50



Jumbo

Set of 1



■ E1028-S1-01 XXL	H 110 L 130 W 130
■ E1028-S1-03 XXL	H 110 L 130 W 130
■ E1027-S1-01 XL	H 100 L 110 W 110
■ E1027-S1-03 XL	H 100 L 110 W 110
■ E1026-S1-01 L	H 90 L 90 W 90
■ E1026-S1-03 L	H 90 L 90 W 90
■ E1025-S1-01 M	H 70 L 70 W 70
■ E1025-S1-03 M	H 70 L 70 W 70
■ E1024-S1-01 S	H 50 L 50 W 50
■ E1024-S1-03 S	H 50 L 50 W 50



Jumbo Middle High

Set of 1

- E1069-S1-01 XXL
- E1070-S1-01 XL
- E1071-S1-01 L
- E1072-S1-01 M



E1069 H 90 | L 140 | W 140
E1070 H 70 | L 110 | W 110
E1071 H 60 | L 90 | W 90
E1072 H 53 | L 70 | W 70

12 | Jumbo XXL Fiberstone

Jumbo Low

Set of 1

- E1050-S1-01 XXL
- E1049-S1-01 XL
- E1048-S1-01 L
- E1047-S1-01 M



E1050 H 28 | L 110 | W 110
E1049 H 26 | L 90 | W 90
E1048 H 25 | L 73 | W 73
E1047 H 24 | L 60 | W 60



E1128-S1-01 M, page 15

Jumbo Cone

Set of 1

- E1062-S1-01 L
- E1062-S1-03 L
- E1063-S1-01 M
- E1063-S1-03 M
- E1064-S1-01 S
- E1064-S1-03 S



E1062 H 97 | Ø 112

E1063 H 85 | Ø 98

E1064 H 73 | Ø 83



Jumbo

Set of 1

- E1040-S1-01 L
- E1040-S1-03 L
- E1060-S1-01 M
- E1060-S1-03 M
- E1061-S1-01 S
- E1061-S1-03 S



E1040 H 97 | Ø 112

E1060 H 85 | Ø 98

E1061 H 73 | Ø 83



Jumbo Bowl

Set of 3

- E1044-S3-01
- E1044-S3-03



H 27 | Ø 110

H 22 | Ø 85

H 17 | Ø 70



Jort

Set of 1

- E1125-S1-01 XL
- E1125-S1-03 XL
- E1126-S1-01 L
- E1126-S1-03 L



E1125 H 75 | L 150 | W 60

E1126 H 60 | L 120 | W 45

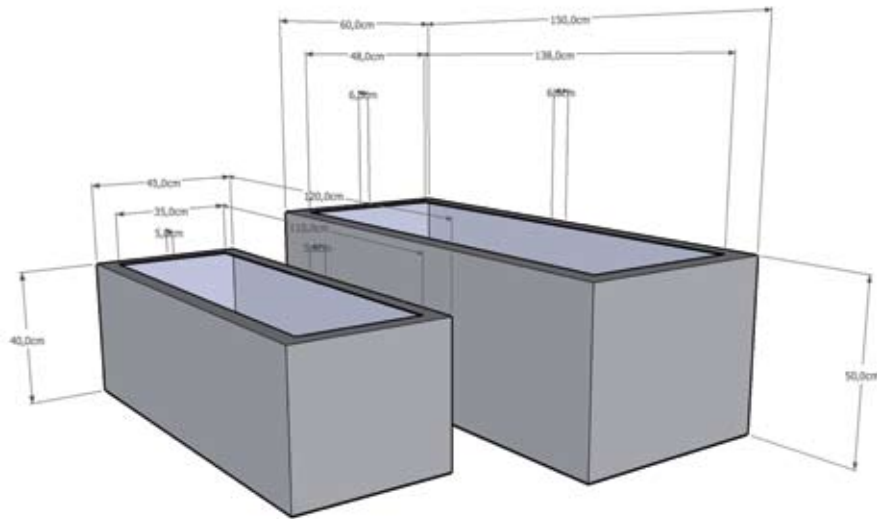



Jort

Set of 1

- E1127-S1-01 M
- E1127-S1-03 M
- E1128-S1-01 S
- E1128-S1-03 S



E1127 H 50 | L 150 | W 60

E1128 H 40 | L 120 | W 45

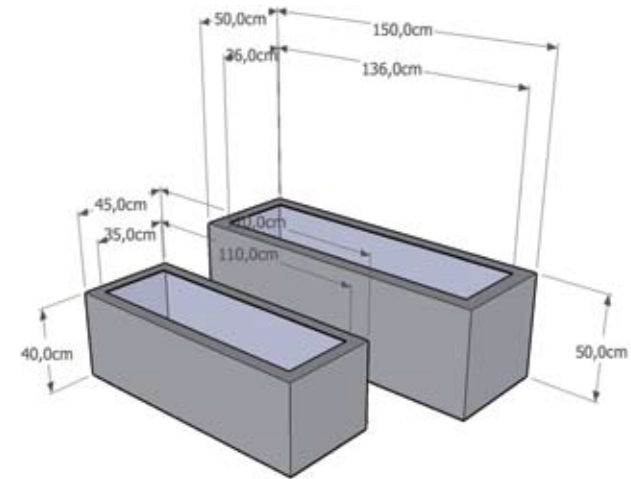

Jumbo seating

Set of 1

■ E1122-S1-01

■ E1122-S1-03



H 47,5 | L 140 | W 140

16 | Jumbo XXL Fiberstone





E1123-S1-01, E1122-S1-03, page 16

Jumbo seating XXL

Set of 1

- E1123-S1-01
- E1123-S1-03



H 45 | L 150 | W 80



Jumbo seating XXXL

Set of 1

- E1129-S1-01
- E1129-S1-03



H 45 | L 200 | W 80



Glossy Fiberstone



NL Een nieuw, sterk, samengesteld uit polyester, steenpoeder, fiberglas en hoogglans autolak. De sterke lak heeft geen onderhoud nodig, is UV-bestendig en krasvast.

Het binnenwerk neemt geen water op, zodat de artikelen vorstbestendig zijn. Ook de laklagen zullen niet kapot vriezen. Tijdens hogere (buiten)temperaturen blijven de artikelen vormvast.

Kortom, geschikt voor zowel gebruik binnen als (permanent) buiten.

Wegens de succesvolle serie Glossy White is de serie uitgebreid met Glossy Black, Grey en Red.

Niet geschikt als waterbassin.

EN A new strong maintenance free material consisting of polyester, stone grid, fiberglass and ultra glossy car lacquer. The strong lacquer doesn't need maintenance, withstand UV-light and is scratch resistant.

The inside doesn't take in water, and therefore doesn't freeze. The lacquer is also frost proof.

High(er) outside temperatures have no influence on the steadiness of the shapes.

In short, fit for both inside and (permanent) outdoor use.

The successful introduction of Glossy White had lead to introducing now the Glossy products in Black, Grey and Red.

Not suitable as a water basin.

DE Ein neues kräftiges Material, hergestellt aus Polyester, Steinpulver, Fiberglas und hochglänzendem Autolack. Dieser starke Lack braucht keine besondere Pflege, ist UV-resistent und kratzfest.

Das innere Material nimmt keine Feuchtigkeit auf, was die Artikel frostbeständig macht. Auch die Lackschichten frieren nicht kaputt. Bei höheren Außentemperaturen bleibt das Material formfest.

Im Kurzem: empfohlen für drinnen und draußen.

Die erfolgreiche Produkteinführung von Glossy White hat uns dazu gebracht die Farbserien zu erweitern mit Glossy Black, Grey und Red.

Nicht zu benutzen als Wasserbassin.

Block

Set of 3

- E1073-S3-W
- E1073-S3-R
- E1073-S3-G
- E1073-S3-B



H 60 | L 60 | W 60
H 45 | L 45 | W 45
H 30 | L 30 | W 30



Block

Set of 2

- E1074-S2-W
- E1074-S2-R
- E1074-S2-G
- E1074-S2-B



H 50 | L 50 | W 50
H 40 | L 40 | W 40



Block Middle High

Set of 2

□ E1143-S2-W



H 36 | L 45 | W 45
H 26,5 | L 33 | W 33



Block Low

Set of 2

□ E1142-S2-W



H 20 | L 45 | W 45
H 15 | L 33 | W 33



Ying

Set of 1

Remark:
double bottom

- E1006-S1-W
- E1006-S1-R
- E1006-S1-G
- E1006-S1-B



H 150 | L 40 | W 40



Yong

Set of 2

Remark:
double bottom

□ E1131-S1-W



H 120 | L 35 | W 35



Yang

Set of 1

Remark:
double bottom

□ E1005-S1-W

■ E1005-S1-R

■ E1005-S1-G

■ E1005-S1-B



H 100 | L 35 | W 35



Topper

For Ying, Yang
& Yong

J2001-S1-S H 10 | L 41,5 | W 41,5

J2002-S1-S H 7 | L 35 | W 35



The finishing touch for items E1005,
E1006 and E1131: silver coloured plates
closing in or over Ying, Yong and/or Yang.
Which makes them highly functional.

Jort

Set of 2

- E1008-S2-W
- E1008-S2-R
- E1008-S2-G
- E1008-S2-B



H 50 | L 100 | W 40
H 40 | L 80 | W 29



Jort L

Set of 1

- E1009-S1-W



H 72 | L 95 | W 38



Bouvy

Set of 2

- E1016-S2-W
- E1016-S2-R
- E1016-S2-G
- E1016-S2-B



H 80 | L 40 | W 40
H 60 | L 30 | W 30





Bowl

Set of 2

- E1065-S2-W
- E1065-S2-R
- E1065-S2-G
- E1065-S2-B



H 38 | Ø 60

H 28 | Ø 45

Bowl E1065-S2-W
Yong E1131-S1-W
Topper E2002-S1-S

Sunny

Set of 2

- E1110-S2-W
- E1110-S2-R
- E1110-S2-G



H 27 | Ø 45

H 20 | Ø 33





E1111-S2-W

Cora

Set of 2

E1111-S2-W



H 36,5 | Ø 72

H 25,5 | Ø 47



Beth

Set of 1

E1119-S1-W

E1112-S1-W



E1119 H 67 | Ø 77

E1112 H 43,5 | Ø 50



Lara

Set of 3

□ E1114-S3-W



H 84 | Ø 71,5

H 69,5 | Ø 60

H 55,5 | Ø 48



Ben

Set of 2

□ E1051-S2-W



H 72 | Ø 52

H 55 | Ø 40



Dax

Set of 1

Remark:
double bottom

□ E1043-100-W

□ E1043-80-W



E1043-100 H 100 | Ø 47

E1043-80 H 80 | Ø 37



Ace

Set of 3

Remark:
double bottom

□ E1115-S3-W



H 150 | L 60 | W 60
H 116 | L 46,5 | W 46,5
H 90 | L 36 | W 36



Ace

Set of 2

Remark:
double bottom

□ E1116-S2-W



H 116 | L 46,5 | W 46,5
H 90 | L 36 | W 36



Bond

Set of 3

□ E1117-S3-W



H 85 | Ø 68
H 61,5 | Ø 48,5
H 45 | Ø 35



Dice

Set of 2

□ E1118-S2-W



H 60 | Ø 46

H 44 | Ø 34



Sphere

Set of 3

□ E1001-S3-W

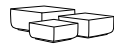

H 22,5 | L 49 | W 49

H 18 | L 40 | W 40

H 15 | L 32,5 | W 32,5



E1118-S2-W

Bucket

Set of 3

□ E1004-S3-W



H 50 | Ø 58

H 40 | Ø 49

H 36 | Ø 40



Beau

Set of 1

Remark:
double bottom

□ E1011-100-W

□ E1011-80-W



E1011-100 H 100 | L 43 | W 43

E1011-80 H 75 | L 33 | W 33



Max

Set of 3

□ E1014-S3-W



H 50 | Ø 51

H 43 | Ø 43

H 29 | Ø 29,5





E1124-S1-W

Izy

Set of 1
Remark:
double bottom

□ E1113-S1-W



H 80 | L 38 | W 38



Hole in one

Set of 1
Remark:
double bottom

□ E1124-S1-W



H 100 | L 80 | W 49,5



Balcony



NL Buiten kwaliteit ook voor binnen

- lichtgewicht
- waterdicht
- strakke vormgeving

EN Outdoor quality also for indoor

- leight weight
- water proof
- modern design

DE Outdoor-Qualität für den Innenbereich

- wenig Gewicht
- Wasserdicht
- moderne Formgebung



E1103-S1-W

Balcony L

4 in a box

- E1103-S1-01
- E1105-S1-03
- E1103-S1-R
- E1103-S1-G
- E1103-S1-W



H 20 | L 50 | W 20

Balcony S

4 in a box

- E1104-S1-01
- E1105-S1-03
- E1104-S1-R
- E1104-S1-G
- E1104-S1-W



H 20 | L 40 | W 20

Balcony XL

3 in a box

- E1105-S1-01
- E1105-S1-03
- E1105-S1-R
- E1105-S1-G
- E1105-S1-W



H 20 | L 80 | W 20



Bloemimex BV
www.plantenbakkenplanten.nl

Glossy Fiberstone Candlesticks

NL

Kandelaars gemaakt van fiberstone, afgewerkt met hoogglans autolak. Geschikt voor binnen en buiten.

EN

Candlesticks made of fiberstone, finished with high gloss car lacquer. For in and outdoor.

DE

Leuchter aus Fiberstone, gefertigt mit hochglänzendem Autolack. Für drinnen und draussen.



Merry L

Set of 1
4 in a box

E1133-S1-W

E1133-S1-B



H 50 | L 17 | W 17

Merry M

Set of 1
9 in a box

E1134-S1-W

E1134-S1-B



H 35 | L 12 | W 12

Merry S

Set of 1
8 in a box

E1141-S1-W

E1141-S1-B



H 25 | L 9 | W 9



Frosty L

Set of 1
4 in a box

□ E1135-S1-W
■ E1135-S1-B



H 70 | L 17 | W 17

Frosty M

Set of 1
4 in a box

□ E1136-S1-W
■ E1136-S1-B



H 50 | L 12,5 | W 12,5

Frosty S

Set of 1
8 in a box

□ E1137-S1-W
■ E1137-S1-B



H 35 | L 9 | W 9



Candy L

Set of 1
4 in a box

□ E1138-S1-W
■ E1137-S1-B



H 70 | L 19,5 | W 19,5

Candy M

Set of 1
4 in a box

□ E1139-S1-W
■ E1139-S1-B



H 51 | L 16 | W 16

Candy S

Set of 1
8 in a box

□ E1140-S1-W
■ E1140-S1-B



H 35 | L 10 | W 10



Fiberstone Picnic



NL

- strakke vormgeving
- eenvoudig
- licht in gewicht
- zeer onderhoudsvriendelijk
- voor binnen en buiten geschikt
- duurzaam

EN

- modern design
- simplicity
- light weight
- hardly any maintenance
- for in and outdoor
- long lasting

DE

- moderne Formgebung
- ehrlich
- leicht in Gewicht
- sehr Pflegeleicht
- für drinnen und draußen
- dauerhaft

E1020-S1-01
E1019-S1-01
E1029-S1-01

Table L

Set of 1

■ E1020-S1-01



H 75 | L 200 | W 80



Table M

Set of 1

■ E1013-S1-01



H 75 | L 140 | W 90



Table S

Set of 1

■ E1007-S1-01



H 75 | L 100 | W 100



Chair

Set of 1

■ E1019-S1-01



H 45 | L 40 | W 40



Bench

Set of 1

■ E1029-S1-01



H 45 | L 174 | W 40





E1067-S1-W
E1132-S1-W M

Table L

Set of 1

□ E1068-S1-W

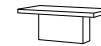

H 77 | L 200 | W 100



Table

Set of 1

- E1132-S1-W M
- E1130-S1-W S



E1132 H 77 | L 140 | W 140

E1130 H 77 | L 100 | W 100



Bench

Set of 1

- E1092-S1-W



H 45 | L 200 | W 40



Stool

Set of 1



□ E1067-S1-W



H 45 | L 40 | W 40

Bloemimex BV
www.plantenbakkenplanten.nl

E1068-S1-W
E1067-S1-W
E1092-S1-W
E1111-S2-W





Fiberstone



NL De strakke vormgeving, het lichte gewicht, het fraaie natuurlijke uiterlijk, de weersbestendigheid en het zeer sterke materiaal...dat zijn de succesfactoren van de Fiberstone collectie van Pottery Pots.

Op traditionele wijze handgemaakt van glasvezel, versterkt met steengruis, in een verhouding van 35-65%.

Het steengruis zit aan de buitenkant van het artikel. Hierdoor hebben deze artikelen dan ook een 100% natuurlijke uitstraling! Elk item, pot, tafel, bank of kruk, heeft zijn eigen individuele karakter. Toch blijven de kleurschakeringen beperkt. Eenvoudig in het onderhoud, een- tot tweemaal per jaar speciale olie aanbrengen, en de staat van "nieuw" komt weer helemaal terug. Olie alleen te gebruiken voor kleur 01.

EN The modern design, the light weight, the beautiful natural looks, the weatherproof quality, and high strength, these are the criteria on which the success of Pottery Pots Fiberstone collection is based.

Made in a traditional manner by hand of glass fiber, strengthened with stone grid in a proportion of 35-65%.

With the stone grid on the outside the pots get their 100% natural appearance.

Each item, being pot, table, bank or stool, has its own individual character, although colour shades are minimised.

Easy to maintain: once or twice a year the application of a special oil will bring back the original looks.

Only to use for colour 01.

DE Moderne Formgebung, leichtes Gewicht, ein schönes, natürliches Aussehen, wetterfeste Qualität, große Stärke, das sind die Kriterien, die den großen Erfolg der Fiberstone collection von Pottery Pots möglich gemacht haben.

Handgemacht auf traditionelle Weise, Glasfiber verstärkt mit Steinpulver, in einem Verhältnis von 35-65%. Das Steinpulver wird an der Außenseite aufgebracht und gibt den Töpfen ihre 100% natürliches Aussehen. Jeder Artikel, Topf, Tisch, Bank oder Hocker, hat seinen eigenen individuellen Charakter. Ausbleichen durch Sonnenlicht wurde reduziert. Durch 1-2 maliges Einölen des Produktes mit unserem Spezialöl erhalten Sie den Originalfarbton zurück. Eine einfache Pflege, durch die Sie lange Freude an dem Produkt haben werden. Nur für schwarz.

Sphere

Set of 3

- E1001-S3-01
- E1001-S3-03



H 19 | L 50 | W 50
H 17 | L 40 | W 40
H 15 | L 30 | W 30



Block

Set of 4

- E1003-S4-01
- E1003-S4-03

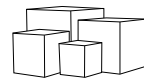

H 60 | L 60 | W 60
H 50 | L 50 | W 50
H 40 | L 40 | W 40
H 30 | L 30 | W 30



Block

Set of 3

- E1002-S3-01
- E1002-S3-03

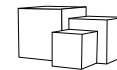

H 50 | L 50 | W 50
H 40 | L 40 | W 40
H 30 | L 30 | W 30



Block

Set of 3

■ E1101-S3-01



H 40 | L 40 | W 40

H 30 | L 30 | W 30

H 20 | L 20 | W 20



Bucket

Set of 4

■ E1004-S4-01

■ E1004-S4-03



H 60 | Ø 70

H 50 | Ø 58

H 40 | Ø 50

H 35 | Ø 40



Yang

Set of 1

Also usable as pillar

Remark:

double bottom

■ E1005-S1-01

■ E1005-S1-03



H 100 | L 35 | W 35



Yong

Set of 1

Also usable as pillar

Remark:

double bottom

■ E1131-S1-01

■ E1131-S1-03



H 120 | L 35 | W 35



Ying

Set of 1

Also usable as
pillar

Remark:

double bottom

■ E1006-S1-01

■ E1006-S1-03



H 150 | L 40 | W 40



J2002-S1-S



Topper

For Ying, Yang
& Yong

J2001-S1-S H 10 | L 41,5 | W 41,5

J2002-S1-S H 7 | L 35 | W 35



The finishing touch for items E1005,
E1006 and E1131: silver coloured plates
closing in or over Ying, Yong and/or Yang.
Which makes them highly functional.

Jort

Set of 2

- E1008-S2-01
- E1008-S2-03



H 50 | L 100 | W 40

H 40 | L 80 | W 30





E1009-S1-03

Jort

Set of 1

- E1066-S1-01
- E1066-S1-03



H 40 | L 80 | W 30



Jort L

Set of 1

Remark:
double bottom

- E1009-S1-01
- E1009-S1-03



H 72 | L 95 | W 38



Jort XL

Set of 1

Remark:
double bottom

■ E1057-S1-01



H 100 | L 45 | W 100



Belle

Set of 2

■ E1010-S2-01

■ E1010-S2-03



H 90 | Ø 60

H 70 | Ø 47



Beau

Set of 2

Remark:
double bottom

■ E1011-S2-01

■ E1011-S2-03



H 100 | L 43 | W 43

H 76 | L 32 | W 32



Thom

Set of 3

■ E1012-S3-01
■ E1012-S3-03



H 90 | L 66 | W 66
H 68 | L 50 | W 50
H 50 | L 37 | W 37



Max

Set of 3

■ E1014-S3-01
■ E1014-S3-03



H 50 | Ø 51
H 43 | Ø 43
H 29 | Ø 29,5



Don

Set of 2

■ E1015-S2-01
■ E1015-S2-03



H 27 | Ø 80
H 21 | Ø 59



Bouvy

Set of 2

- E1016-S2-01
- E1016-S2-03



H 80 | L 40 | W 40
H 60 | L 30 | W 30



Klax

Set of 2

- E1018-S2-01
- E1018-S2-03



H 80 | Ø 40
H 60 | Ø 30



E1003-S4-01

Jip - Pillar

Set of 2

■ E1055-S2-01



H 113 | L 30 | W 30

H 85 | L 22 | W 22



Nax

Set of 2

■ E1036-S2-01

■ E1036-S2-03



H 101 | Ø 50

H 70 | Ø 35



Drax

Set of 3

■ E1037-S3-01

■ E1037-S3-03



H 27 | L 79 | W 40,5

H 23 | L 68 | W 34

H 20 | L 59 | W 28



Pax

Set of 2

■ E1042-S2-01
■ E1042-S2-03



H 67 | Ø 66
H 46 | Ø 44



Dax

Set of 2

Remark:
double bottom

■ E1043-S2-01
■ E1043-S2-03



H 100 | Ø 47
H 80 | Ø 37



Ben

Set of 2

■ E1051-S2-01
■ E1051-S2-03



H 72 | Ø 52
H 55 | Ø 40



Bowl

Set of 2

- E1065-S2-01
- E1065-S2-03

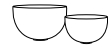

H 38 | Ø 60
H 28 | Ø 45



Sunny

Set of 2

- E1110-S2-01



H 27 | Ø 45
H 20 | Ø 33



E1003-S4-01

Cora

Set of 2

■ E1111-S2-01



H 36,5 | Ø 72

H 25,5 | Ø 47



Beth

Set of 1

■ E1112-S1-01

■ E1119-S1-01



E1112 H 43,5 | Ø 50

E1119 H 67 | Ø 77



Lara

Set of 3

■ E1114-S3-01



H 84 | Ø 71,5

H 69,5 | Ø 60

H 55,5 | Ø 48



Ace

Set of 3

Remark:
double bottom



■ E1115-S3-01



H 150 | L 60 | W 60
H 116 | L 46,5 | W 46,5
H 90 | L 36 | W 36

Ace

Set of 2

Remark:
double bottom



■ E1116-S2-01



H 116 | L 46,5 | W 46,5
H 90 | L 36 | W 36

Bond

Set of 3



■ E1117-S3-01



H 85 | Ø 68
H 61,5 | Ø 48,5
H 44 | Ø 35

Dice

Set of 2



■ E1118-S2-01



H 60 | Ø 46

H 40 | Ø 34

Izy

Set of 1

Remark:
double bottom



■ E1113-S1-01



H 80 | L 38 | W 38

Hole in one

Set of 1

Remark:
double bottom



■ E1124-S1-01

■ E1124-S1-03



H 100 | L 80 | W 49,5

Small Pottery



NL Buiten kwaliteit ook voor binnen:

- lichtgewicht
- waterdicht
- ideaal voor de bloemist
- fraaie vormgeving

EN Outdoor quality also for indoor use:

- leight weight
- water proof
- ideal for florists
- beautiful design

DE Qualität von Draußen
im Drinnenbereich

- liches Gewicht
- Wasserbestendig
- Ideal für Blumengeschäft
- schöne Formgebung



Tim

Set of 3
1 in a box

■ E1030-S3-01



H 43 | Ø 46
H 32 | Ø 35
H 25 | Ø 26



Maud

Set of 2
1 in a box

■ E1031-S2-01



H 22 | Ø 49
H 18 | Ø 40



Peter

Set of 2
2 in a box

■ E1032-S3-01



H 18 | Ø 30
H 13 | Ø 20



Puk

Set of 3
4 in a box

■ E1033-S3-01



H 25 | Ø 25
H 20 | Ø 20
H 15 | Ø 15



Fleur

Set of 3
2 in a box

■ E1035-S3-01

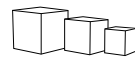

H 25 | L 25 | W 25
H 20 | L 20 | W 20
H 15 | L 15 | W 15



Block

Set of 2

■ E1102-S2-01



H 30 | L 30 | W 30
H 20 | L 20 | W 20





Monique

Set of 2
2 in a box

■ E1034-S2-01



H 9 | Ø 34
H 7 | Ø 24



Monique

Set of 3
1 in a box

■ E1058-S3-01



H 14 | Ø 54
H 12 | Ø 44
H 10 | Ø 34



E1030-S3-01

Tim

Set of 3
1 in a box

□ E1031-S3-W
(glossy)



H 42 | Ø 47
H 30 | Ø 35
H 23 | Ø 26



Maud

Set of 2
1 in a box

□ E1031-S2-W
(glossy)



H 21 | Ø 50
H 17,5 | Ø 40



Peter

Set of 2
4 in a box

□ E1032-S2-W
(glossy)



H 18 | Ø 30
H 13 | Ø 20



Puk

Set of 3
8 in a box

□ E1033-S3-W
(glossy)



H 25 | Ø 25
H 20 | Ø 20
H 15 | Ø 15



Fleur

Set of 3
8 in a box

□ E1035-S3-W
(glossy)



H 25 | L 25 | W 25
H 20 | L 20 | W 20
H 15 | L 15 | W 15



Monique

Set of 2
3 in a box

□ E1034-S2-W
(glossy)



H 12 | Ø 43,5
H 10 | Ø 34,5



Beth

Set of 1
4 / 2 in a box

- E3003-S1-W
- E3002-S1-W
(glossy)



E3003 H 20,5 | Ø 26
E3002 25 | Ø 31



Jort

Set of 2
4 in a box

- E3001-S2-W
(glossy)



H 16 | L 30 | W 15
H 11 | L 20 | W 10



Pandora

Set of 2
2 in a box

- E3005-S2-W
(glossy)



H 10 | L 64 | W 24
H 8 | L 50 | W 19



Mini Dorant

Set of 2
4 in a box

□ E3004-S2-W
(glossy)



H 16,5 | L 44 | W 18
H 13 | L 32,5 | W 14



Bloemimex BV
www.plantenbakkenplanten.nl

E3003-S1-W-S3-01



Super Light Weight



NL

- Hoge kwaliteit voor aantrekkelijke prijzen
- Mooie vormgeving, zeer licht van gewicht.
- 100 % waterdicht
- Voor binnengebruik

EN

- High quality at appealing prices
- Fine design, very light weight.
- 100% water tight
- For indoor use only

DE

- Hohe Qualität gegen attraktiven Preisen
- Schöne Formen und sehr leicht in Gewicht
- 100% wasserbeständig
- Für Innengebrauch

Zaandam M en S

Set of 1
12 / 6 in a box

- E4001-S1-04 M
- E4000-S1-04 S



E4001 H 14 | L 35,5 | W 14
E4000 H 10 | L 30,5 | W 9



Edam M en S

Set of 1
8 / 2 in a box

- E4003-S1-04 M
- E4002-S1-04 S



E4003 H 27,5 | Ø 22
E4002 H 21 | Ø 17



Leerdam M, S en XS

Set of 1
18 / 6 / 4 in a box

- E4006-S1-04 M
- E4005-S1-04 S
- E4004-S1-04 XS



E4006 H 18 | Ø 24,5
E4005 H 14,5 | Ø 19
E4004 H 11 | Ø 14



Schardam M, S en XS

Set of 1

12 / 12 / 24 in a box

- E4007-S1-04 M
- E4008-S1-04 S
- E4009-S1-04 XS



E4007 H 15 | L 15 | W 15

E4008 H 12 | L 12 | W 12

E4009 H 10 | L 10 | W 10



Maasdam M en S

Set of 1

8 / 24 in a box

- E4010-S1-04 M
- E4011-S1-04 S



E4010 H 16,5 | L 22 | W 9

E4011 H 10,5 | L 15 | W 6



Schiedam M en S

Set of 1

4 / 9 in a box

- E4012-S1-04 M
- E4013-S1-04 S



E4012 H 34,5 | Ø 20,5

E4013 H 26 | Ø 15,5



Uitdam

Set of 1
2 in a box

■ E4014-S1-04



H 22 | Ø 34



Stellendam M en S

Set of 1
1 in a box

■ E4015-S1-04 M
■ E4016-S1-04 S



E4015 H 57 | Ø 60
E4016 H 48 | Ø 50



Steendam

Set of 1
1 in a box

■ E4017-S1-04



H 45 | L 90 | W 36



Veendam

Set of 2

Per pallet: 12

■ E4018-S2-04



H 60 | Ø 46

H 44 | Ø 34



Muntendam

Set of 1

12 / 6 in a box

■ E4022-S1-08 M

■ E4021-S1-08 S



E4022 H 14 | L 35,5 | W 14

E4021 H 10 | L 30 | W 9



Rijsdam

Set of 1

4 / 6 / 18 in a box

■ E4025-S1-08 M

■ E4024-S1-08 S

■ E4023-S1-08 XS



E4025 H 18 | Ø 24,5

E4024 H 14,5 | Ø 19

E4023 H 11 | Ø 14



Durgerdam

Set of 1

12 / 12 / 24 in a box

- E4026-S1-08 M
- E4027-S1-08 S
- E4026-S1-08 XS



E4026 H 15 | L 15 | W 15
E4027 H 12 | L 12 | W 12
E4028 H 10 | L 10 | W 10

Krabbendam

Set of 1

8 / 24 in a box

- E4029-S1-08 M
- E4030-S1-08 S



E4029 H 16,5 | L 22 | W 9
E4030 H 10,5 | L 15 | W 6

Knollendam

Set of 1

4 / 9 in a box

- E4031-S1-08 M
- E4032-S1-08 S



E4031 H 34,5 | Ø 20,5
E4032 H 26 | Ø 15,5



Budget Eco Pottery

NL Door het mengen van beton, steenpoeder en fiberglas is een nieuw materiaal ontstaan, dat zich eenvoudig laat verwerken tot stoere, maar ook gedetailleerde artikelen.

Sterk, lichtgewicht, stabiel, professioneel afgewerkt.
Dé kenmerken van deze nieuwe producten, die ook nog eens vriendelijk zijn geprijsd.
Geschikt voor binnen en buiten.

Niet geschikt als waterbassin.

EN By mixing concrete, stone powder and fiber glass a brand new material has arisen. Easy to shape to tough yet detailed articles.

Strong, very light weight and professionally finished.
The characteristics for this new product line, which moreover has friendly prices.
For in and outdoor use.

Not to be used as a water basin.

DE Eine ganz neue Mischung von Beton, Steinpulver und Fiberglas gibt ein neues Material, dass sich einfach verarbeiten lässt und robuste doch detaillierte Artikeln liefert.

Kräftig, leicht in Gewicht, und mit professioneller Finish.
Das sind Die Eigenschafte diesen neuen Produkten, die auch noch mal günstig bepreist sind.
Für drinnen und draussen.

Nicht geeignet als Wasserbassin.



Budget Block

set of 3
Minimum order
quantity 16

■ E2002-S3-04



H 50 | L 50 | W 50
H 40 | L 40 | W 40
H 30 | L 30 | W 30



Budget Jort

set of 2
Minimum order
quantity 8

■ E2008-S2-04



H 50 | L 100 | W 40
H 40 | L 80 | W 30



Budget Bouvy

set of 2
Minimum order
quantity 27

■ E2016-S2-04



H 60,5 | L 32,5 | W 32,5
H 45 | L 25 | W 25



Budget Bucket

Set of 3
Minimum order
quantity 16

■ E2004-S3-04



H 51 | Ø 58,5
H 40 | Ø 50
H 36 | Ø 41,5



Budget Yang

Set of 1
Minimum order
quantity 18

■ E2005-S1-04



H 100 | L 33 | W 33



Budget Bowl L, M en S

Set of 1
Minimum order
quantity 36 / 16 / 16

■ E2017-S1-07 L
■ E2018-S1-07 M
■ E2019-S1-07 S



E2017 H 48 | Ø 60
E2018 H 40 | Ø 50
E2019 H 32 | Ø 40



Budget Bouvy

Set of 3
Minimum order
quantity 12

■ E2020-S3-07



H 80 | L 43 | W 43
H 60 | L 32 | W 32
H 45 | L 25 | W 25



Budget Beau

Set of 1
Minimum order
quantity 12

■ E2021-S1-07



H 100 | L 42 | W 42





Budget Friend

Set of 2
Minimum order
quantity 12

■ E2022-S2-07



H 57 | L 55 | W 55
H 44 | L 42 | W 42



Budget Girl

Set of 2
Minimum order
quantity 6

■ E2023-S2-07



H 57 | Ø 68
H 45 | Ø 53



Light Clay



NL

- Een mengsel van steenpoeder, cement en fiberglas.
- Geschikt voor binnen en buiten
- Medium licht van gewicht
- Waterdicht, dus geschikt als plantpot
- Vriendelijk geprijsd
- Ook als kleine potten leverbaar
- Niet geschikt als waterbassin

EN

- A mixture of stone powder, concrete and fiberglass
- Fit for indoor and outdoor usage
- Medium light weight
- Watertight, thus useable as planters
- Amicable price level
- Also in small pottery
- Not to be used as a water basin

DE

- Eine Mischung von Steinpulver, Beton und Fiberglas
- Für drinnen und draußen geeignet
- Mittleres Gewicht
- Wasserdicht, also geeignet als Pflanztopf
- Freundliche Preisen
- Auch kleine Töpfe
- Nicht geeignet als Wasserbassin

Skye

Set of 2

- J1023-S2-07
- J1023-S2-S06
- J1023-S2-S16



H 80 | Ø 48
H 65 | Ø 40



Madeira

Set of 2

- J1024-S2-07
- J1024-S2-S06
- J1024-S2-S16



H 40 | L 40 | W 40
H 30 | L 30 | W 30



Brac

Set of 2

- J1025-S2-07
- J1025-S2-S06
- J1025-S2-S16



H 23 | L 69 | W 34
H 20 | L 59 | W 29



Levanzo

Set of 1

- J1026-S1-07 M
- J1026-S1-S06 M
- J1026-S1-S16 M
- J1027-S1-07 S
- J1027-S1-S06 S
- J1027-S1-S16 S



J1026 H 27 | Ø 23,5

J1027 H 21 | Ø 17,5



Alderney

Set of 1

- J1028-S1-07 L
- J1028-S1-S06 L
- J1028-S1-S16 L
- J1029-S1-07 M
- J1029-S1-S06 M
- J1029-S1-S16 M
- J1030-S1-07 S
- J1030-S1-S06 S
- J1030-S1-S16 S



J1028 H 15 | L 60 | W 25

J1029 H 15,5 | L 40,5 | W 20

J1030 H 14,5 | L 30,5 | W 15,5



J1028-S1-S06 L





Scarborough

Set of 1

- J1031-S1-07 M
- J1031-S1-S06 M
- J1031-S1-S16 M
- J1032-S1-07 S
- J1032-S1-S06 S
- J1032-S1-S16 S



J1031 H 25 | Ø 20
J1032 H 20 | Ø 15,5



St. Cruz

Set of 1

- J1033-S1-07 M
- J1033-S1-S06 M
- J1033-S1-S16 M
- J1034-S1-07 S
- J1034-S1-S06 S
- J1034-S1-S16 S



J1033 H 14,5 | Ø 30
J1034 H 10,5 | Ø 20



Korcula M

Set of 1

- J1035-S1-07
- J1035-S1-S06
- J1035-S1-S16



H 40 | Ø 28



Korcula S

Set of 1

- J1036-S1-07
- J1036-S1-S06
- J1036-S1-S16



H 34,5 | Ø 23



Roatán

Set of 1

- J1037-S1-07
- J1037-S1-S06
- J1037-S1-S16



H 15 | L 15 | W 15



Guernsey

Set of 1

- J1038-S1-07
- J1038-S1-S06
- J1038-S1-S16



H 12,5 | L 29 | W 15



Anglesey

Set of 2

- J1041-S1-07
- J1041-S1-S06
- J1041-S1-S16



H 35 | Ø 70

H 30 | Ø 60



Wolin

Set of 2

- J1042-S2-07
- J1042-S2-S06
- J1042-S2-S16



H 40 | Ø 50

H 30 | Ø 40



Standing low

■ J1045-S1-07
■ J1045-S1-S16



H 35 | L 80 | W 30



Standing

Remark:
double bottom

■ J1044-S1-07
■ J1044-S1-S16



H 80 | L 80 | W 30



Jort Clay

Remark:
double bottom

■ J1043-S1-07
■ J1043-S1-S16



H 80 | L 80 | W 30





Bloemimex BV
www.plantenbakkenplanten.nl

Light Stone Ceramic



NL Light Stone Ceramic potten worden niet in de oven gebakken, maar volgens een bijna vergeten oude techniek met mallen gevormd, waarna ze in de zon worden gedroogd. Het materiaal is samengesteld uit klei, zand en cement, een vernieuwende combinatie van materialen. Hierdoor is de afhankelijkheid van schaarse materialen en energievretende en milieuvervuilende productieprocessen aanzienlijk verminderd. De Light Stone Ceramic potten worden met de hand gevormd en vervolgens waterdicht gemaakt. En dan zijn ze klaar voor hun nieuwe huis. Uw huis?

EN Light Stone pottery products are not baked in kilns, they are sun-dried naturally using a long-forgotten moulding technique and a number of aggregates, such as clay, sand and cement. This innovative material enables to reduce the dependence on scarce materials and more importantly, helps us to minimise waste and pollution from our manufacturing facilities by eliminating entirely the polluting baking process. Light Stone Ceramic products are crafted by hand. After moulding, the Light Stone products are treated with water-proofing protection. Light Stone Ceramic is recommended for indoor use.

DE Light Stone Ceramic Töpfe werden nicht im Ofen gebacken, sondern nach einer sehr alten, fast vergessenen Handwerktechnik, in der Sonne auf natürliche Weise getrocknet. Die Töpfe werden in traditioneller Weise geformt. Es werden Ton, Sand und Zement gemischt. Die Kombination dieser Materialien ist ganz neu, und erlaubt uns unabhängig zu sein von seltener werdenden Materialien. Die Umweltbelastung wird bei dieser Produktionsmethode stark reduziert, weil die Töpfe nicht im Ofen gebrannt werden müssen. Unsere Light Stone Ceramic Töpfe sind handgemacht. Einmal geformt und getrocknet, werden die Produkte wasserdicht gemacht und sind dann bereit für den Einsatz in vielleicht Ihrem Heim?

Londen

Set of 2

- G1011-S2-01
- G1011-S2-03
- G1012-S2-01
- G1012-S2-03
- G1013-S2-01
- G1013-S2-03



G1011

H 30 | Ø 30

H 20 | Ø 20

G1012

H 40 | Ø 40

H 30 | Ø 30

G1013

H 70 | Ø 71

H 55 | Ø 56



Parijs

Set of 2

- G1014-S2-01
- G1014-S2-03



H 80 | Ø 41

H 60 | Ø 30





Berlijn

Set of 2

- G1015-S2-01
- G1015-S2-03
- G1016-S2-01
- G1016-S2-03
- G1016-S2-C02

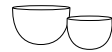

G1015

H 40 | Ø 60

H 30 | Ø 46

G1016

H 25,5 | Ø 40

H 20 | Ø 30



Moskou

Set of 1

- G1017-S1-01
- G1017-S1-03



H 38 | Ø 40



Madrid

Set of 2

- G1018-S2-01
- G1018-S2-03



H 23 | Ø 30
H 15 | Ø 20



Madrid

Set of 2

- G1019-S2-01
- G1019-S2-03



H 30 | Ø 40
H 23 | Ø 30



Rim Pot

Set of 3

- G1024-S3-04
- G1024-S3-11
- G1024-S3-09



H 36 | Ø 37
H 26 | Ø 26
H 20 | Ø 20



Rim Vase

Set of 2

- G1025-S2-04
- G1025-S2-11
- G1025-S2-09



H 60 | Ø 30

H 42 | Ø 22



Rim Low

Set of 2

- G1026-S2-04
- G1026-S2-11
- G1026-S2-09



H 30 | Ø 23

H 20 | Ø 15



Stockholm

Set of 2

- G1023-S2-C02
- G1022-S2-C02



G1023 H 30 | Ø 40

G1023 H 23 | Ø 30

G1022 H 23 | Ø 30

G1022 H 15 | Ø 20



Various

NL Naast de vaste PP collectie heeft Pottery Pots ook een wisselend assortiment.

Meestal bestaande uit seizoensgebonden artikelen.

Wees er snel bij, want op-is-op.

EN Further to the standard PP collection Pottery Pots also has a variable assortment, mainly consisting of seasonal articles.

Hurry, because sold out is sold out.

DE Neben die feste PP Kollektion hat Pottery Pots auch ein wechselnd Sortiment, meistens bestehend aus saisonale Artikeln.

Seien Sie schnell dabei, denn on-ist-on.

Seychellen

Set of 1

J1018-S1-S01

J1018-S1-B

J1017-S1-S01

J1017-S1-B



J1018 H 120 | Ø 50

J1017 H 105 | Ø 50



Bangkok

set of 2

G1027-S2



H 49 | Ø 32

H 45 | Ø 23



Jakarta

set of 2

■ G1028-S2



H 30 | Ø 32

H 20 | Ø 24



Grenada

Set of 1

■ J1039-S1-N

■ J1040-S1-N



J1039 H 150 | L 40 | W 40

J1040 H 100 | L 40 | W 40



Natural Wooden Bowl

Handcarved

Set of 1

■ W.....-S1



Various sizes



Q-line

NL Onze Q-Line producten worden op ouderwetse wijze gelakt, met lak van de lakboom in 6 tot 8 kleurloze laklagen en tot slot de kleurvolle lak.

De basis is gemaakt van een composietmateriaal, resine en fiberglas.

Dit materiaal garandeert grote sterkte, mede dankzij hoge slagvastheid.

EN Our Q-line lacquerware is traditionally made with lacquer from the local lacquer-tree, in 6-8 colourless layers and finally the colourful finish.

The body is made from a composite, resin and fiberglass, which makes it strong and slightly flexible.

DE Unsere Q-Linie Produkte werden auf eine traditionelle Weise lackiert mit Lack von dem Lack-Baum in 6-8 farblose Schichten und zum Ende die Farbschicht.

Der Körper ist aus Resin und Fiberglas gefertigt. Dieses Material garantiert hohe Stärke und ist schlagfest.



Spring Vase 100

Set of 1

- Q1001-S1-0022
- Q1001-S1-0027
- Q1001-S1-6010
- Q1001-S1-6022
- Q1001-S1-6033
- Q1001-S1-6041
- Q1001-S1-749
- Q1001-S1-745
- Q1001-S1-9c



H 100 | L 40 | W 40

Presentation



NL De ideale basis voor winkelpresentaties in verschillende hoogtes.

De hoge kwaliteit lak garandeert duurzaamheid en eenvoudig onderhoud.

EN The ideal booth for shop presentation in various heights.
The high quality lacquer guarantees durability and easy maintenance.

DE Ideal für Laden in verschiedenen Höhen.
Dieser starke Lack garantiert dauerhaftes Gebrauch und einfache Pflege.

Artwood table

Set of 1

■ E1088-S1-A



H 66 | L 300 | W 100



Artwood table

Set of 1

■ E1089-S1-A



H 60 | L 200 | W 100



Artwood table

Set of 1

■ E1090-S1-A



H 20 | L 100 | W 100









Bloeminx BV
www.plantenbakkenplanten.nl

